

E96-409

Bailey®
infi 90

Instruction

Controller/Station Termination Module (NICS01)

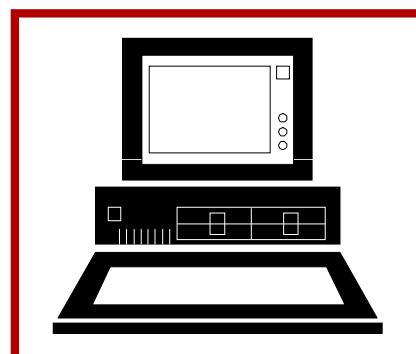
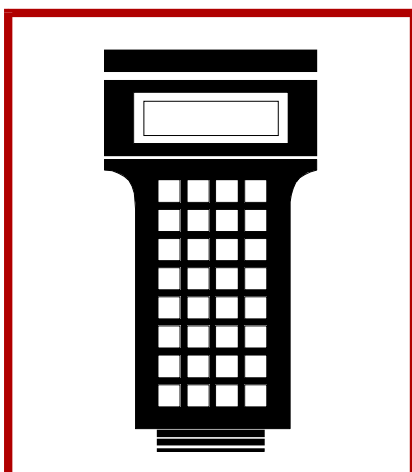
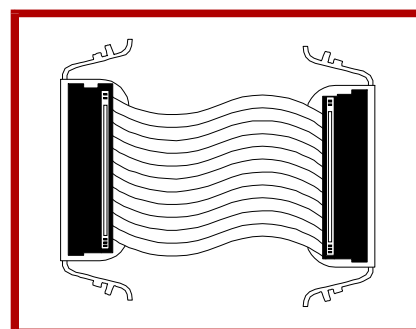
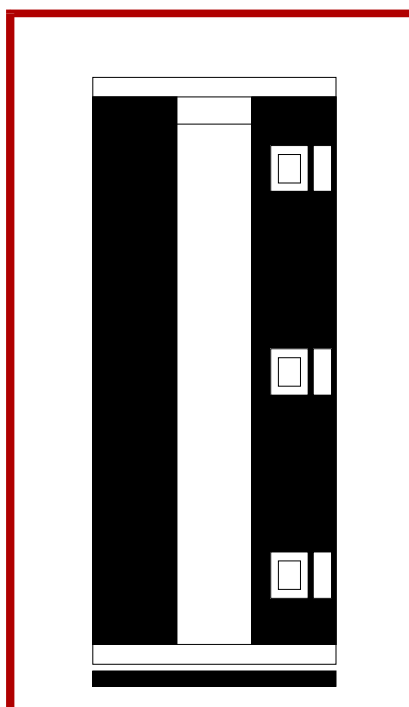
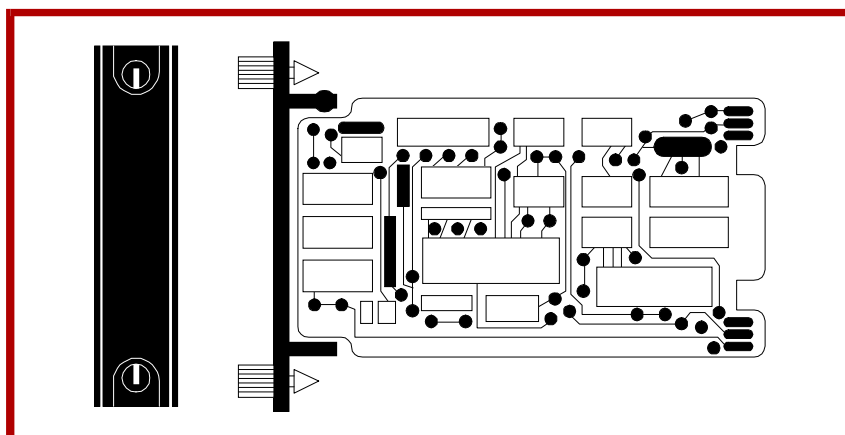
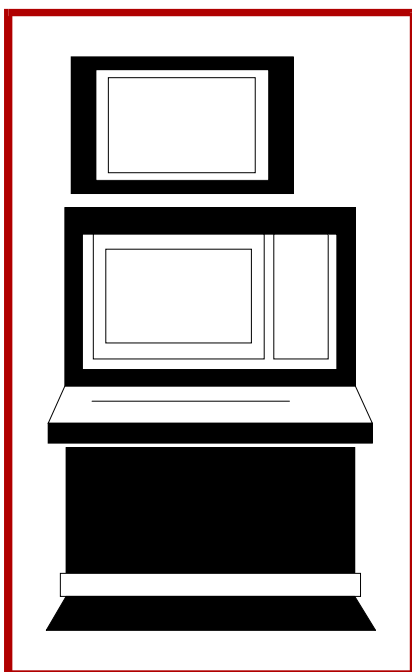

WARNING notices as used in this instruction apply to hazards or unsafe practices that could result in personal injury or death.

CAUTION notices apply to hazards or unsafe practices that could result in property damage.

NOTES highlight procedures and contain information that assists the operator in understanding the information contained in this instruction.

WARNING

INSTRUCTION MANUALS

DO NOT INSTALL, MAINTAIN, OR OPERATE THIS EQUIPMENT WITHOUT READING, UNDERSTANDING, AND FOLLOWING THE PROPER **Elsag Bailey** INSTRUCTIONS AND MANUALS; OTHERWISE, INJURY OR DAMAGE MAY RESULT.

RADIO FREQUENCY INTERFERENCE

MOST ELECTRONIC EQUIPMENT IS INFLUENCED BY RADIO FREQUENCY INTERFERENCE (RFI). CAUTION SHOULD BE EXERCISED WITH REGARD TO THE USE OF PORTABLE COMMUNICATIONS EQUIPMENT IN THE AREA AROUND SUCH EQUIPMENT. PRUDENT PRACTICE DICTATES THAT SIGNS SHOULD BE POSTED IN THE VICINITY OF THE EQUIPMENT CAUTIONING AGAINST THE USE OF PORTABLE COMMUNICATIONS EQUIPMENT.

POSSIBLE PROCESS UPSETS

MAINTENANCE MUST BE PERFORMED ONLY BY QUALIFIED PERSONNEL AND ONLY AFTER SECURING EQUIPMENT CONTROLLED BY THIS PRODUCT. ADJUSTING OR REMOVING THIS PRODUCT WHILE IT IS IN THE SYSTEM MAY UPSET THE PROCESS BEING CONTROLLED. SOME PROCESS UPSETS MAY CAUSE INJURY OR DAMAGE.

AVERTISSEMENT

MANUELS D'OPÉRATION

NE PAS METTRE EN PLACE, RÉPARER OU FAIRE FONCTIONNER L'ÉQUIPEMENT SANS AVOIR LU, COMPRIS ET SUIVI LES INSTRUCTIONS RÉGLEMENTAIRES DE **Elsag Bailey**. TOUTE NÉGLIGENCE À CET ÉGARD POURRAIT ÊTRE UNE CAUSE D'ACCIDENT OU DE DÉFAILLANCE DU MATÉRIEL.

PERTURBATIONS PAR FRÉQUENCE RADIO

LA PLUPART DES ÉQUIPEMENTS ÉLECTRONIQUES SONT SENSIBLES AUX PERTURBATIONS PAR FRÉQUENCE RADIO. DES PRÉCAUTIONS DEVRONT ÊTRE PRISES LORS DE L'UTILISATION DU MATÉRIEL DE COMMUNICATION PORTATIF. LA PRUDENCE EXIGE QUE LES PRÉCAUTIONS À PRENDRE DANS CE CAS SOIENT SIGNALÉES AUX ENDROITS VOULUS DANS VOTRE USINE.

PERTURBATIONS DU PROCÉDÉ

L'ENTRETIEN DOIT ÊTRE ASSURÉ PAR UNE PERSONNE QUALIFIÉE EN CONSIDÉRANT L'ASPECT SÉCURITAIRE DES ÉQUIPEMENTS CONTRÔLÉS PAR CE PRODUIT. L'AJUSTEMENT ET/OU L'EXTRACTION DE CE PRODUIT PEUT OCCASIONNER DES À-COUPS AU PROCÉDÉ CONTRÔLE LORSQU'IL EST INSÉRÉ DANS UNE SYSTÈME ACTIF. CES À-COUPS PEUVENT ÉGALEMENT OCCASIONNER DES BLESSURES OU DES DOMMAGES MATÉRIELS.

NOTICE

The information contained in this document is subject to change without notice.

Elsag Bailey, its affiliates, employees, and agents, and the authors and contributors to this publication specifically disclaim all liabilities and warranties, express and implied (including warranties of merchantability and fitness for a particular purpose), for the accuracy, currency, completeness, and/or reliability of the information contained herein and/or for the fitness for any particular use and/or for the performance of any material and/or equipment selected in whole or part with the user of/or in reliance upon information contained herein. Selection of materials and/or equipment is at the sole risk of the user of this publication.

This document contains proprietary information of Elsag Bailey, Elsag Bailey Process Automation, and is issued in strict confidence. Its use, or reproduction for use, for the reverse engineering, development or manufacture of hardware or software described herein is prohibited. No part of this document may be photocopied or reproduced without the prior written consent of Elsag Bailey.

Preface

The NICS01 Controller/Station Termination Module terminates and provides for:

- Field wiring when IMCIS02 and IMQRS02 Slave Modules are used to supply analog and digital field I/O.
- Digital control stations and digital indicator stations.
- Interconnecting digital control stations and digital indicator stations using the NIDS01 Termination Module.
- IMCOM03 and IMCOM04 Controller Modules and IMQRC01 Quick Response Controllers.
- Serial link communications from MFP/MFC modules to stations.

This product instruction explains how to install and configure the ICS termination module.

List of Effective Pages

Total number of pages in this manual is 41, consisting of the following:

Page No.	Change Date
Preface	Original
List of Effective Pages	Original
iii through vii	Original
1-1 through 1-4	Original
2-1 through 2-9	Original
3-1	Original
4-1 through 4-2	Original
5-1	Original
A-1 through A-2	Original
B-1 through B-2	Original
C-1 through C-2	Original
D-1 through D-2	Original
E-1 through E-4	Original
F-1 through F-3	Original
G-1	Original
Index-1	Original

When an update is received, insert the latest changed pages and dispose of the superseded pages.

NOTE: On an update page, the changed text or table is indicated by a vertical bar in the outer margin of the page adjacent to the changed area. A changed figure is indicated by a vertical bar in the outer margin next to the figure caption. The date the update was prepared will appear beside the page number.

Safety Summary

**GENERAL
WARNINGS****Equipment Environment**

All components, whether in transportation, operation or storage must be in a noncorrosive environment.

Electrical Shock Hazard During Maintenance

Disconnect power or take precautions to insure that contact with energized parts is avoided when servicing.

**SPECIFIC
WARNINGS**

If input or output circuits are a shock hazard after disconnecting system power at the power entry panel, then the door of the cabinet containing these externally powered circuits must be marked with a warning stating that multiple power sources exist. (p. 2-8)

**SPECIFIC
CAUTIONS**

Remove modules (slave, master or termination) from their assigned slots before installing a cable to that slot. Also, remove stations from their housing before installing a cable to that housing. Failure to do so could result in damage to the module or station. (p. 2-5)

It is strongly recommended that **all** power (cabinet, I/O, etc.) be turned off before doing any termination module wiring. Failure to do so could result in equipment damage. Do not apply power until all wire connections are verified. (p. 2-8, 4-1, 4-2)

Sommaire de Sécurité

AVERTISSEMENTS D'ORDRE GÉNÉRAL

Environnement de l'équipement

Nes pas soumettre les composantes a une atmosphere corrosive lors du transport, de l'entreposage ou de l'utilisation.

Risques de chocs electriques lor de l'entretien

S'assurer de debrancher l'alimentation ou de prendre les precautions necessaires a eviter tout contact avec des composants sous tension lors de l'entretien.

AVERTISSEMENTS D'ORDRE SPÉCIFIQUE

Si des circuits d'entree ou de sortie sont alimentes a partir de sources extremes, ils presentent un risque de choc electrique meme lorsque l'alimentation du systeme est debranchee du panneau d'entree l'alimentation. Le cas echeant, un avertissement signalant la presence de sources d'alimentation multiples doit entre appose sur la porte de l'armoire. (p. 2-8)

ATTENTIONS D'ORDRE SPÉCIFIQUE

Retirer les modules (asservi, maître ou carte de raccordement) de leur position assignée avant d'installer un câble à cette position. Egalement, retirer les postes de commande de leur boîtier avant d'installer un câble dans ce boîtier. Des dommages au module ou au poste pourraient résulter d'un manquement à cette procédure. (p. 2-5)

Il est fortement recommandé que **toutes** les alimentations (armoire, E/S, etc.) soient coupées avant d'effectuer quelque raccord que ce soit sur un carte de raccordement. Un manquement à ces instructions pourrait causer des dommages à l'équipement. Ne pas rebrancher les alimentations avant d'avoir vérifié tous les raccords. (p. 2-8, 4-1, 4-2)

Table of Contents

	<i>Page</i>
SECTION 1 - INTRODUCTION	1-1
OVERVIEW	1-1
INTENDED USER	1-2
INSTRUCTION CONTENT	1-2
HOW TO USE THIS MANUAL	1-2
GLOSSARY OF TERMS AND ABBREVIATIONS	1-2
SPECIFICATIONS	1-3
REFERENCE DOCUMENTS	1-4
NOMENCLATURE	1-4
SECTION 2 - INSTALLATION	2-1
INTRODUCTION	2-1
SPECIAL HANDLING	2-1
UNPACKING AND INSPECTION	2-2
SETUP/PHYSICAL INSTALLATION	2-2
Fuse Installation	2-2
Configuring Dipswitches	2-3
Cable Connections	2-3
Cable Installation	2-5
NKTU02, NKTU12 and NKTM01	2-5
NKTD02, NKTD12	2-6
6634408_2 Ribbon Cable	2-7
Installing the Termination Module	2-7
Terminal Wiring	2-7
SECTION 3 - MAINTENANCE	3-1
INTRODUCTION	3-1
MAINTENANCE SCHEDULE	3-1
SECTION 4 - REPAIR/REPLACEMENT PROCEDURES	4-1
INTRODUCTION	4-1
MODULE REPLACEMENT PROCEDURES	4-1
FUSE REPLACEMENT PROCEDURES	4-2
SECTION 5 - SUPPORT SERVICES	5-1
INTRODUCTION	5-1
REPLACEMENT PARTS AND ORDERING INFORMATION	5-1
TRAINING	5-1
TECHNICAL DOCUMENTATION	5-1
APPENDIX A - IMCIS02 CONTROL I/O SLAVE MODULE CONFIGURATION	A-1
INTRODUCTION	A-1
APPENDIX B - IMCOM03 AND IMCOM04 CONTROLLER MODULE CONFIGURATION	B-1
INTRODUCTION	B-1
APPENDIX C - IMQRC01 QUICK RESPONSE CONTROLLER MODULE CONFIGURATION	C-1
INTRODUCTION	C-1

Table of Contents (continued)

	<i>Page</i>
APPENDIX D - IMQRS02 QUICK RESPONSE SLAVE MODULE CONFIGURATION	D-1
INTRODUCTION	D-1
APPENDIX E - IISAC01 ANALOG CONTROL STATION CONFIGURATION	E-1
INTRODUCTION	E-1
APPENDIX F - NDCS03 DIGITAL CONTROL STATION CONFIGURATION	F-1
INTRODUCTION	F-1
APPENDIX G - NDIS01 DIGITAL INDICATOR STATION CONFIGURATION	G-1
INTRODUCTION	G-1

List of Figures

<i>No.</i>	<i>Title</i>	<i>Page</i>
1-1.	Example NICS01 Application	1-1
2-1.	NICS01 Termination Module Layout	2-2
2-2.	NICS01 Cable Connections to One Station	2-3
2-3.	NICS01 Cable Connection to NIDS01 Termination Module	2-4
2-4.	NICS01 Cable Connections to Multiple Stations and Serial Links	2-4
2-5.	Termination Module Installation	2-7
2-6.	NICS01 Terminal Strip Assignments	2-9
2-7.	Example Input Circuits	2-9
A-1.	Control I/O Slave Module	A-1
B-1.	Controller Module	B-1
C-1.	Quick Response Controller Module	C-1
D-1.	Quick Response Slave Module	D-1
E-1.	Analog Control Station	E-1
F-1.	Bypass Board	F-1
F-2.	Digital Control Station Board	F-2
G-1.	Digital Indicator Station	G-1

List of Tables

<i>No.</i>	<i>Title</i>	<i>Page</i>
1-1.	Glossary of Terms and Abbreviations	1-2
1-2.	Specifications.....	1-3
1-3.	Reference Documents	1-4
1-4.	Nomenclature	1-4
2-1.	Switch S1, S2, S3 and S4 Settings	2-3
2-2.	Switch S5 Settings	2-3
2-3.	NICS01 Cable Applications.....	2-5
3-1.	Maintenance Schedule	3-1
5-1.	Spare Parts List	5-1
A-1.	Example Switch S1 Settings.....	A-1
A-2.	Switch S2 Settings	A-2
A-3.	Switch S3 Settings	A-2
A-4.	Jumpers J1 through J6 Settings	A-2
B-1.	Switch S2 and S3 Settings	B-1
B-2.	Switch S4 Settings (Modes)	B-2
B-3.	Switch S4 Settings (Module Address).....	B-2
B-4.	Jumper J1, J2 and J3 Settings	B-2
C-1.	Switch S2 and S3 Settings	C-1
C-2.	Switch S4 Settings (Modes)	C-2
C-3.	Switch S4 Settings (Module Address).....	C-2
C-4.	Jumper J1, J2 and J3 Settings	C-2
D-1.	Example Switch S1 Settings.....	D-1
D-2.	Switch S2 Settings	D-2
D-3.	Switch S3 Settings	D-2
D-4.	Jumpers J1 through J6 Settings	D-2
E-1.	Switch S1 Settings	E-1
E-2.	Switch S2 Settings	E-2
E-3.	Switch S3 Settings	E-2
E-4.	Switch S4 Settings	E-3
E-5.	Jumper JP1, JP2, and JP3 Settings	E-3
E-6.	Electric Drive Mode Display Options	E-4
F-1.	Dipshunt XU16 Settings	F-2
F-2.	Jumper J1 and J2 Settings	F-2
F-3.	Switch S1 Settings	F-3
F-4.	Jumpers J1 through J5 Settings	F-3
G-1.	Address Switch Settings.....	G-1
G-2.	Jumper J1 Settings.....	G-1

SECTION 1 - INTRODUCTION

OVERVIEW

The NICS01 Controller/Station Termination Module provides I/O connections for IMQRS02 and IMCIS02 Slave Modules, IMCOM03 and IMCOM04 Controller Modules and IMQRC01 Quick Response Controllers. Also provided are connections for control stations (no analog output bypass capability), digital indicator stations, and serial link connections to multi-function processor/multi-function controller modules through their respective termination modules. An NIDS01 Termination Module can be connected to the ICS module with a ribbon cable. This allows the daisy-chaining of additional stations and enables the analog output bypass capability of the first control station in a daisy chain. Figure 1-1 shows an example NICS01 application.

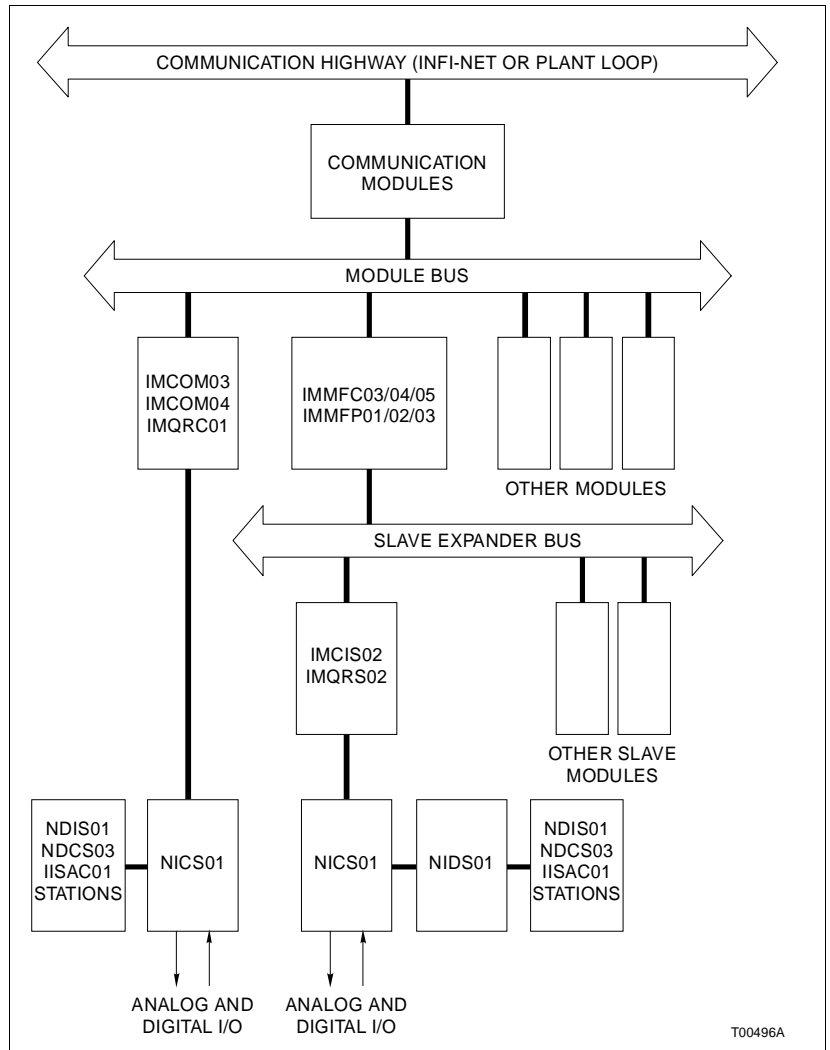

Figure 1-1. Example NICS01 Application

INTENDED USER

System engineers and technicians should read this manual before installing and placing the NICS01 Termination Module into operation. **Do not** put the ICS termination module into operation until this instruction is read and understood.

INSTRUCTION CONTENT

This manual has twelve sections:

Introduction Contains an overview of the features, specifications and a description of the ICS module.

Installation Describes precautions to observe when handling modules and setup procedures required before module operation. This section also discusses dipswitch settings and installation procedures.

Maintenance Provides a maintenance schedule.

Repair/Replacement Procedures Details how to replace an ICS module.

Support Services Describes the support services (spare parts, training, documentation, etc.) available from Bailey Controls Company.

Appendices A through G Provide quick reference configuration information about the IMCIS02, IMCOM03, IMCOM04, IMQRC01 and IMQRS02 modules. Also provided is quick reference configuration information about the IISAC01, NDCS03 and NDIS01 stations.

HOW TO USE THIS MANUAL

Read through this manual in sequence. Read the installation section thoroughly. Do the steps in order. Complete all steps in the installation section before operating the ICS module. Refer to the **Table of Contents** or **Index** to find specific information after the module is operating.

GLOSSARY OF TERMS AND ABBREVIATIONS

Table 1-1 lists definitions of the terms and abbreviations used in this instruction. G

Table 1-1. Glossary of Terms and Abbreviations

Term	Definition
Analog	Continuously variable as opposed to discretely variable.
Bus	A channel or path for transferring data, electrical signals and power.
COM	Controller module.

Table 1-1. Glossary of Terms and Abbreviations (continued)

Term	Definition
DCS	Digital control station. Provides monitoring and allows manipulation of a single process control loop and communicates with the MFP module. It has front panel LED bar graphs that display set point, process variable and control output values.
Digital	A discretely variable signal usually having only two states, <i>on</i> or <i>off</i> .
DIS	Digital indicator station. A panel mounted device that displays information from controller, multi-function controller and multi-function processor modules.
MFC	Multi-function controller module. A multiple-loop controller with data acquisition and information processing capabilities.
MFP	Multi-function processor module. A multiple-loop controller with data acquisition and information processing capabilities.
MMU	Module mounting unit. A card cage that provides electrical and communication support for INFI 90 [®] /Network 90 [®] modules.
QRC	Quick response controller.
QRS	Quick response slave.
Serial Link Wire	Two insulated 22 gauge wires twisted together. Each wire of the twisted pair consists of seven strands of 30 gauge wire. This twisted pair is shielded with a 36 gauge woven shield drain wire. Bailey raw material P/N R2041-0397.
SAC	Analog control station. Provides monitoring and allows manipulation of a single process control loop and communicates with the MFC, MFP and COM modules. It has front panel LED bar graphs that display set point, process variable and control output values.
TM	Termination module. Provides input/output connection between plant equipment and INFI 90/Network 90 modules.
TMU	Termination mounting unit. A card cage that provides housing for INFI 90/Network 90 termination modules.

SPECIFICATIONS

Refer to Table 1-2 for the specifications of the NICS01 Termination Module.

Table 1-2. Specifications

Physical Attribute/Function	Capabilities
Surge Protection	Meets IEEE-472-1974 surge withstand capability test. ¹
Certification	CSA certified for use as process control equipment in an ordinary (non-hazardous) location.
Environmental	
Ambient Temperature	0° to 70° C (32° to 158° F).
Relative Humidity	0% to 95% up to 55° C (131° F) (noncondensing). 0% to 45% up to 70° C (158° F) (noncondensing).
Air Quality	Noncorrosive.
Mounting	Occupies one slot in a standard INFI 90 termination mounting unit.

NOTE: 1. Does not meet test when the NKTMO1 cable is used.

[®] Registered trademarks of Elsasg Bailey Process Automation.

REFERENCE DOCUMENTS

Table 1-3 lists the documents referenced in this instruction.

Table 1-3. Reference Documents

Document Number	Document
I-E93-902-1	Digital Control Station (NDCS03)
I-E96-116	Digital Indicator Station (NDIS01)
I-E96-117	Analog Control Station (IISAC01)
I-E96-207	Controller Modules (IMCOM03/04)
I-E96-215	Quick Response Controller (IMQRC01)
I-E96-306	Control I/O Slave Module (IMCIS02)
I-E96-316	Quick Response Slave Module (IMQRS02)
I-E96-401	Multi-Function Controller Termination Module (NIMF01/02)
I-E96-412	Digital Logic Station Termination Module (NIDS01)
I-E96-413	Multi-Function Processor Termination Module (NIMP01/02)
I-E96-415	Remote Link Termination Module (NIRL03)

NOMENCLATURE

Table 1-4 is a list of related hardware.

Table 1-4. Nomenclature

Nomenclature	Hardware
NICS01	Controller/station termination module.
NKTU02 (PVC) and NKTU12 (non-PVC)	Cable from NICS01 to IMCIS02, IMCOM03, IMCOM04, IMQRC01 and IMQRS02 modules.
NKTM01 (Ribbon)	Cable from NICS01 to IMCIS02, IMCOM03, IMCOM04, IMQRC01 and IMQRS02 modules.
NKTD02 (PVC) and NKTD12 (non-PVC)	Cable from NICS01 to NDCS03, NDIS01 or IISAC01 stations (no analog output bypass capability).
Bailey Raw Material P/N R2041-0397	Serial link wire.
258436_1	Cable retaining kit used when at least one round cable is connected to the TMU.
6634408_2	Ribbon cable from J1 connector of NICS01 module to J1 connector of NIDS01 module.

SECTION 2 - INSTALLATION

INTRODUCTION

This section explains how to configure and install the NICS01 Controller/Station Termination Module. Read, understand and complete the steps in the order they appear before using the ICS module.

SPECIAL HANDLING

Observe these steps when handling electronic circuitry:

NOTE: Always use Bailey's Field Static Kit (P/N 1948385A1 - consisting of two wrist straps, ground cord assembly, static dissipative work surface and alligator clip) when working with the modules. The kit connects the technician and the static dissipative work surface to the same ground point to prevent damage to the modules by electrostatic discharge.

1. **Use Static Protective Packaging.** Keep the modules in the static protective packaging until you are ready to install them in the system. Save the packaging for future use.
2. **Ground Packaging Before Opening.** Before opening the packaging holding an assembly with CMOS devices, touch it to the equipment housing or a ground to equalize charges.
3. **Avoid Touching Circuitry.** Handle assemblies by the edges; avoid touching the circuitry.
4. **Avoid Partial Connection of CMOS Device.** Verify that all devices connected to the module are properly grounded before using them.
5. **Ground Test Equipment.**
6. **Use Antistatic Field Service Vacuum.** Remove dust from the module if necessary.
7. **Use a Grounded Wrist Strap.** Connect the wrist strap to the appropriate grounding plug on the power entry panel. The grounding plug on the power entry panel is connected to the chassis common ground.
8. **Do Not Use Lead Pencils to Set Dipswitches.** To avoid contamination of switch contacts that can result in unnecessary circuit board malfunction, do not use a lead pencil to set a dipswitch.

UNPACKING AND INSPECTION

1. Examine the hardware immediately for shipping damage.
2. Notify the nearest Bailey Controls sales office of any such damage.
3. File a claim for any damage with the transportation company that handled the shipment.
4. Use the original packing material and container to store the hardware.
5. Store the hardware in an environment of good air quality, free from temperature and moisture extremes.

SETUP/PHYSICAL INSTALLATION

This section explains how to configure and install the ICS module. The required procedures are fuse installation, dipswitch configuration, installing the termination module itself, cable connections and termination wiring.

Fuse Installation

A 4.0 amp/250 volt fuse (Bailey P/N 194776A14001) should be installed in every ICS module. If the fuse is not installed, insert the fuse into clip F1 (See Figure 2-1 for fuse clip locations).

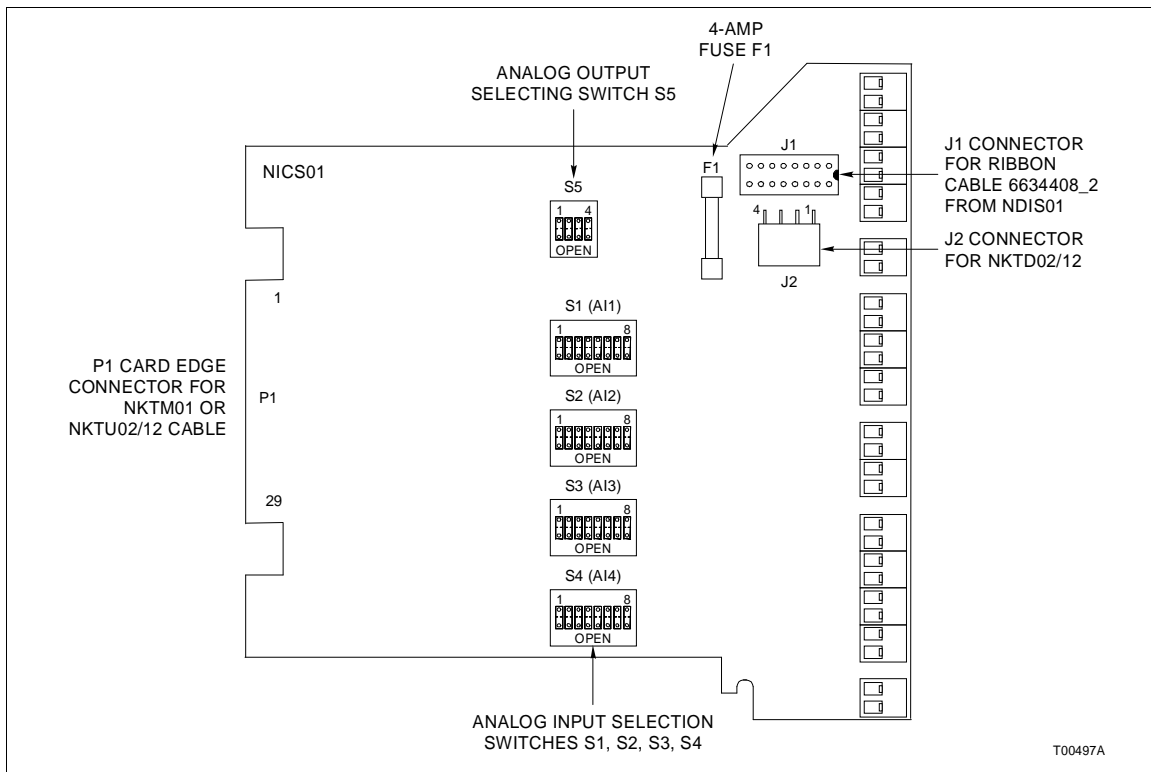

Figure 2-1. NICS01 Termination Module Layout

Configuring Dipswitches

Configure the termination module for the types of inputs and outputs desired using dipswitches S1 through S5. Tables 2-1 and 2-2 show the possible dipswitch settings.

Table 2-1. Switch S1, S2, S3 and S4 Settings

Analog Input Signal Type	Switch Position							
	1	2	3	4	5	6	7	8
System powered (4-20 mA)	1	1	1	1	1	1	0	0
Externally powered (4-20 mA)	0	0	0	0	0	1	1	1
Single ended voltage (1-5 VDC)	0	0	0	1	0	1	1	1
Differential voltage (1-5 VDC)	0	0	0	0	0	0	1	1

NOTE: 0 represents the OPEN or OFF side of the switch. 1 represents the CLOSED or ON side of the switch.

Table 2-2. Switch S5 Settings

Analog Output Signal Type	Switch Position ^{1,2}			
	1	2	3	4
Both outputs are 1-5 VDC	1	1	1	1
Analog Output 1 is 1-5 VDC, Analog Output 2 is 4-20 mA	1	1	0	0
Analog Output 1 is 4-20 mA, Analog Output 2 is 1-5 VDC	0	0	1	1
Both outputs are 4-20 mA	0	0	0	0

NOTES:

1. 0 represents the OPEN or OFF side of the switch. 1 represents the CLOSED or ON side of the switch.
2. Switch Positions 1 and 2 represent Analog Output 1 and Switch positions 3 and 4 represent Analog Output 2.

Cable Connections

The NICS01 Controller/Station Termination Module terminates analog and digital I/O signals, and interfaces them directly to a master/slave module. Figures 2-2, 2-3, and 2-4 show the cables to use and their connections for several different applications of the ICS module. Table 2-3 lists each cable and its application. See Figure 2-1 for the location of cable connectors P1, J1 and J2.

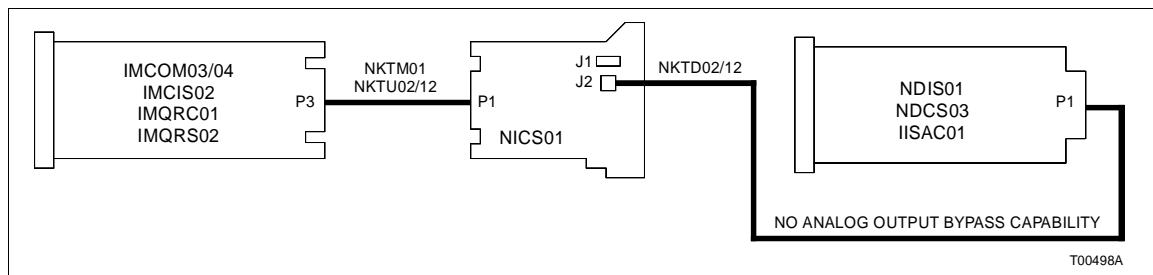

Figure 2-2. NICS01 Cable Connections to One Station

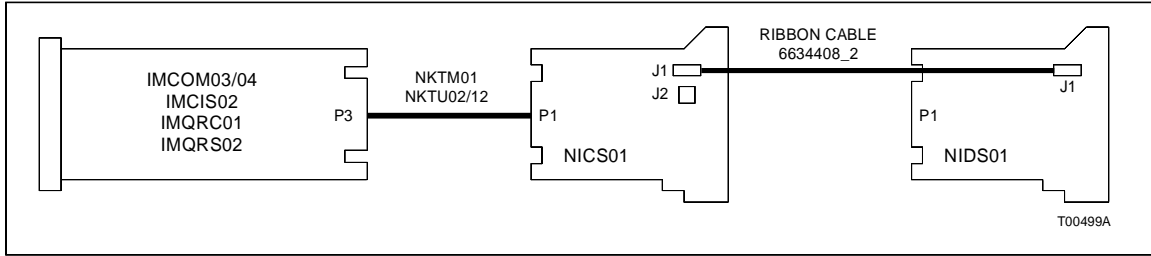

Figure 2-3. NICS01 Cable Connection to NIDS01 Termination Module

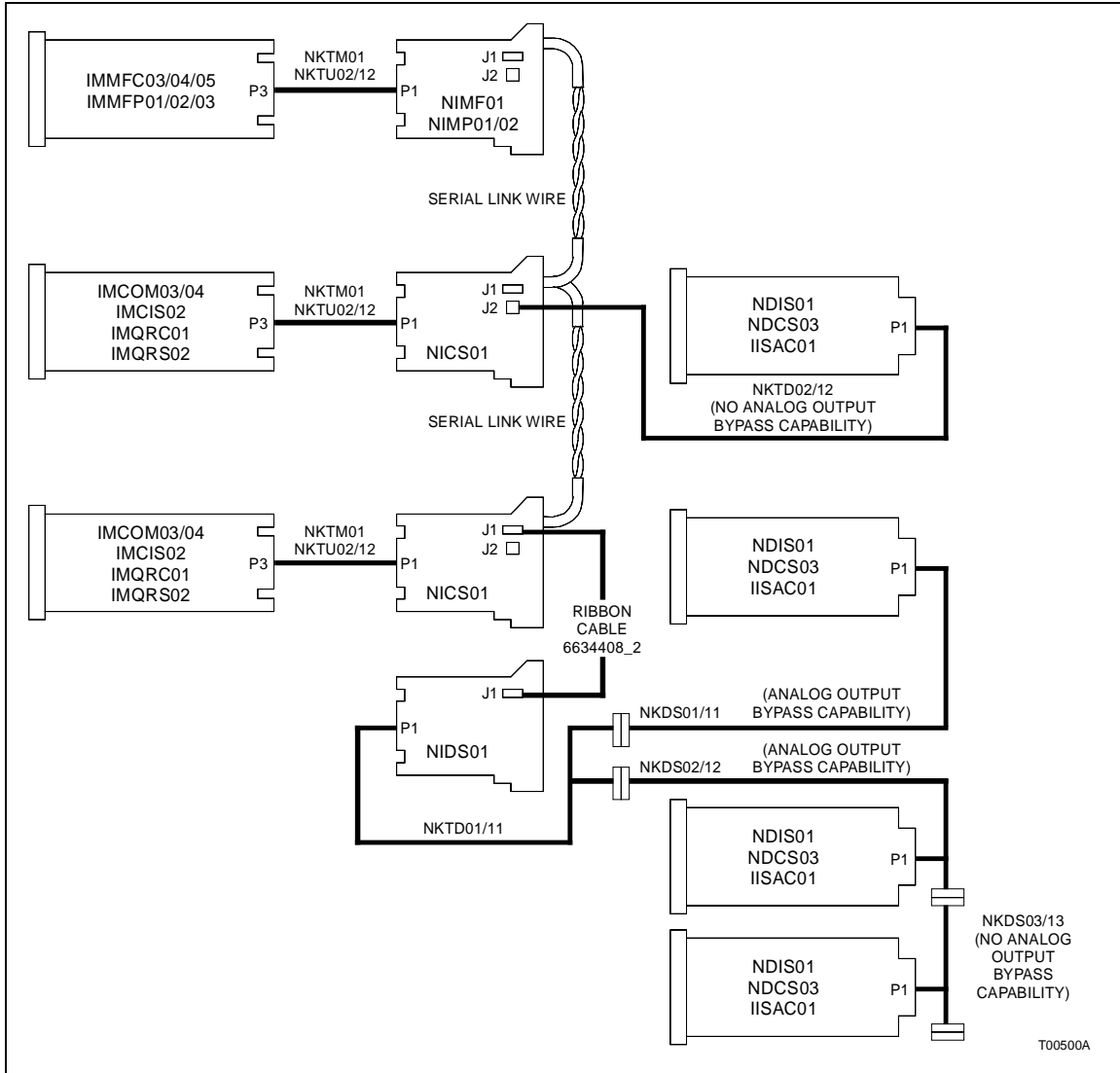

Figure 2-4. NICS01 Cable Connections to Multiple Stations and Serial Links

Table 2-3. NICS01 Cable Applications

Nomenclature/Description	Application	Connections	Max. Length Meters (Feet)
NKTU02 PVC Jacket Termination Cable	Connects ICS module to master slave module	P1 of ICS module to P3 of master/slave module	61 (200)
NKTU12 non-PVC Jacket Termination Cable			
NKTM01 Ribbon Cable	Connects ICS module to master/slave module	P1 of ICS module to P3 of master/slave module	30 (100)
NKTD02 PVC Jacket Termination Cable	Connects ICS module to a station	J2 of ICS module to P1 of the station	183 (600)
NKTD12 non-PVC Jacket Termination Cable			
Serial Link Wire	Enables serial link from ICS to NICS01, NIMF01, NIMP01/02, or NIRL03	Terminal strip of ICS module to other termination module strip.	N/A
6634408_2 Ribbon Cable	Connects ICS module to the NIDS01 module	J1 of ICS module to J1 of the NIDS01 module.	N/A
Standard 14 to 22 AWG Wire	Connects field and power wiring to ICS module	Field or power source to the ICS terminal strip.	N/A

Cable Installation

Remove the front cover of the termination module before trying to install cables. Use the following descriptions when installing cables.

NKTU02, NKTU12 and NKTM01

CAUTION	Remove modules (slave, master or termination) from their assigned slots before installing a cable to that slot. Also, remove stations from their housing before installing a cable to that housing. Failure to do so could result in damage to the module or station.
ATTENTION	Retirer les modules (asservi, maître ou carte de raccordement) de leur position assignée avant d'installer un câble à cette position. Egalement, retirer les postes de commande de leur boîtier avant d'installer un câble dans ce boîtier. Des dommages au module ou au poste pourraient résulter d'un manquement à cette procédure.

This cable connects the ICS module to a master/slave module. To install the cable:

1. Pull the master/slave module out several inches from the module mounting unit (MMU) backplane.

2. If round type cables are already installed in the termination mounting unit (TMU), remove the cable retaining bracket.
3. If the NKTU02 or NKTU12 cable is used, insert the J2 end of the cable into the MMU backplane slot assigned to the master/slave module. If the NKTM01 cable is used, insert one end of the cable into the MMU backplane slot assigned to the master/slave module. The cable should latch securely in place. Card edge connector P3 of the master/slave module connects to this end of the cable.
4. If the NKTU02 or NKTU12 cable is used, connect the shield wire extending from the J2 end of the cable to the shield bus.
5. If the NKTU02 or NKTU12 cable is used, insert the J1 end of the cable into the TMU backplane slot assigned to the ICS module. If the NKTM01 cable is used, insert the unused end of the cable into the TMU backplane slot assigned to the ICS module. The cable should latch securely in place. Card edge connector P1 of the ICS module connects to this end of the cable.
6. Insert the master/slave module in the module mounting unit until it locks into place.
7. Replace or add the cable retaining bracket if round type cables are installed in the termination mounting unit.

NKTD02, NKTD12

This cable connects the ICS module to a single NDCS03, NDIS01, or IISAC01 station. Install the cable as follows:

1. Remove the NDIS01, NDCS03, or IISAC01 station from the station housing.
2. Insert the J2 end of the cable into the station housing backplane. Viewing the station from the back, the cable inserts into the right slot (use the left slot for an NDCS03 station with analog output bypass capability). The cable should latch securely into place. Card edge connector P1 of the station circuit board connects to this end of the cable.
3. Insert the J1 end of the cable into the J2 connector of the ICS module. The cable should latch securely into place.
4. Install the NDIS01, NDCS03, or IISAC01 station into the station housing.

6634408_2 RIBBON CABLE

This cable connects the ICS module to an NIDS01 module. To install the cable:

1. Insert one end of the cable into the J1 connector of the ICS module.
2. Insert the other end of the cable into the J1 connector of the NIDS01 Termination Module.

Installing the Termination Module

The ICS module inserts into a standard INFI 90 termination mounting unit (TMU) and occupies one slot. To install:

NOTE: Insure all dipswitches are configured prior to installation.

1. Verify slot assignment of the ICS module.
2. Align the ICS module with the guide rails in the termination mounting unit and partially insert the module (See Figure 2-5).

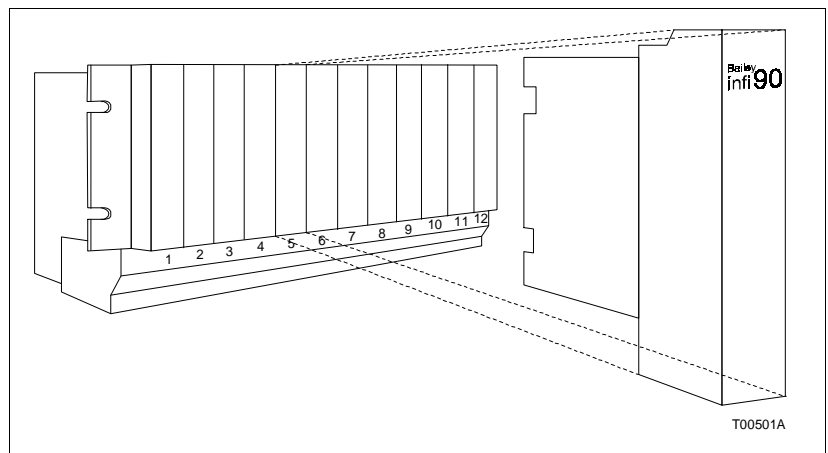

Figure 2-5. Termination Module Installation

Terminal Wiring

Field, serial link and power wiring must be connected to the terminal strip. See Figure 2-6 for ICS terminal strip assignments. The serial link provides a communication path between a master module and stations. Serial link wiring should be Bailey serial link wire. See Figure 2-7 for example input circuits.

WARNING

If input or output circuits are a shock hazard after disconnecting system power at the power entry panel, then the door of the cabinet containing these externally powered circuits must be marked with a warning stating that multiple power sources exist.

AVERTISSEMENT

Si des circuits d'entree ou de sortie sont alimentes a partir de sources extremes, ils presentent un risque de choc electrique meme lorsque l'alimentation du systeme est debranchee du panneau d'entree l'alimentation. Le cas echeant, un avertissement signalant la presence de sources d'alimentation multiples doit entre appose sur la porte de l'armoire.

CAUTION

It is strongly recommended that *all* power (cabinet, I/O, etc.) be turned off before doing any termination module wiring. Failure to do so could result in equipment damage. Do not apply power until all wire connections are verified.

ATTENTION

Il est fortement recommande que *toutes* les alimentations (armoire, E/S, etc.) soient coupées avant d'effectuer quelque raccord que ce soit sur un carte de raccordement. Un manquement à ces instructions pourrait causer des dommage à l'équipement. Ne pas rebrancher les alimentations avant d'avoir vérifié tous les raccordements.

To connect field, serial link and power wiring:

NOTE: Proper polarity of all signals must be maintained.

1. Insure that the ICS module is pulled out far enough to gain access to the terminal strip.
2. Feed the field and serial link wiring into the terminal strip area and connect them to the appropriate terminals.
3. Connect a 14 AWG wire from the +24 VDC bus of the termination mounting unit to the +24 VDC terminal of the ICS module.
4. Connect a 14 AWG wire from the common bus of the termination mounting unit to the common terminal of the ICS module.
5. Insert the module until it locks securely into place.
6. Replace the front cover.

The NICS01 is ready for operation if:

1. The fuse is installed.
2. The dipswitches are configured for the types of inputs and outputs desired.
3. All required cables are installed and verified.
4. Power is connected and applied to the ICS module.

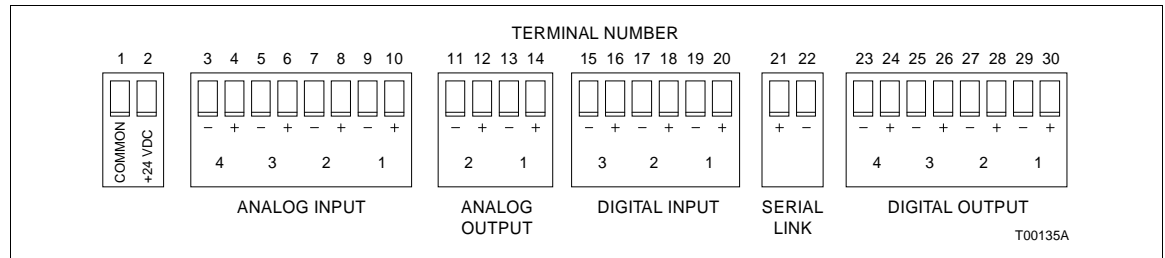

Figure 2-6. NICS01 Terminal Strip Assignments

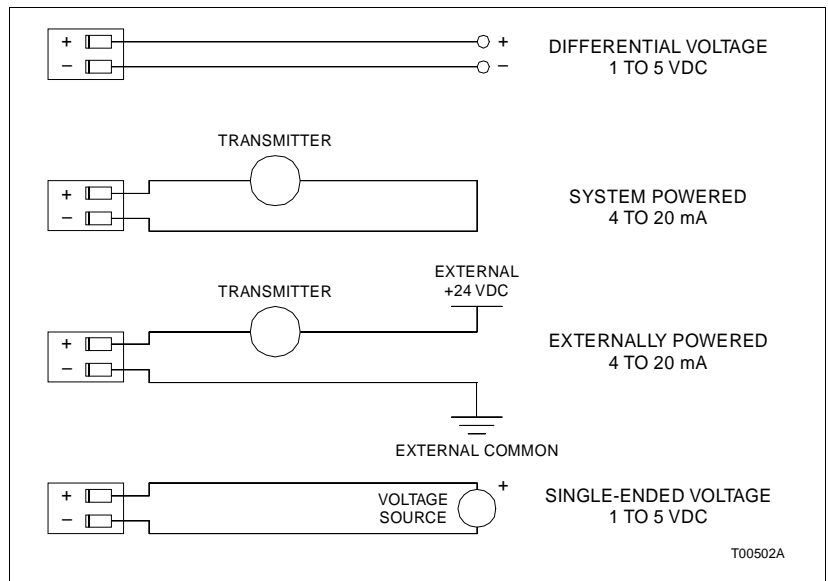

Figure 2-7. Example Input Circuits

SECTION 3 - MAINTENANCE

INTRODUCTION

The controller/station termination module requires limited maintenance. This section contains a maintenance schedule.

MAINTENANCE SCHEDULE

Execute the tasks in Table 3-1 at the specified intervals.

Table 3-1. Maintenance Schedule

Task	Interval
Clean and tighten all power and field wiring connections.	Every 6 months or during plant shutdown, whichever occurs first.
Use a static safe vacuum cleaner to remove dust from:	
Modules.	
Module mounting unit. Termination modules. Termination mounting unit.	

SECTION 4 - REPAIR/REPLACEMENT PROCEDURES

INTRODUCTION

This section explains the replacement procedures for the controller/station termination module.

MODULE REPLACEMENT PROCEDURES

If an ICS module is faulty, replace it with a new one. To replace an ICS termination module:

CAUTION

It is strongly recommended that *all* power (cabinet, I/O, etc.) be turned off before doing any termination module wiring. Failure to do so could result in equipment damage. Do not apply power until all wire connections are verified.

ATTENTION

Il est fortement recommandé que *toutes* les alimentations (armoire, E/S, etc.) soient coupées avant d'effectuer quelque raccord que ce soit sur un carte de raccordement. Un manquement à ces instructions pourrait causer des dommages à l'équipement. Ne pas rebrancher les alimentations avant d'avoir vérifié tous les raccordements.

1. Turn off power to the PCU containing the defective ICS module.
2. Remove the front cover from the defective ICS module.
3. Label and remove all wiring and cables from the defective ICS module.
4. Remove the defective ICS module from the termination mounting unit.
5. Verify that the 4.0 amp/250 volt fuse is installed in fuse clip F1 of the replacement ICS module. If not already installed, insert the fuse into fuse clip F1.
6. Set the switches on the replacement ICS module according to the installation instructions.
7. Connect all wiring and cables removed in Step 3 to the replacement ICS module.
8. Verify proper wiring and cable connections to the replacement ICS module.
9. Install the replacement ICS module into the termination mounting unit.

10. Install the front cover on the replacement ICS module.
11. Apply power to the PCU containing the replacement ICS module.

FUSE REPLACEMENT PROCEDURES

If the fuse is faulty, replace it with a new one. To replace a fuse:

CAUTION

It is strongly recommended that *all* power (cabinet, I/O, etc.) be turned off before doing any termination module wiring. Failure to do so could result in equipment damage. Do not apply power until all wire connections are verified.

ATTENTION

Il est fortement recommandé que *toutes* les alimentations (armoire, E/S, etc.) soient coupées avant d'effectuer quelque raccord que ce soit sur un carte de raccordement. Un manquement à ces instructions pourrait causer des dommages à l'équipement. Ne pas rebrancher les alimentations avant d'avoir vérifié tous les raccordements.

1. Turn off power to the PCU containing the ICS module.
2. Remove the front cover of the ICS module.
3. Pull the ICS module out far enough to gain access to the fuse clip F1.
4. Remove the faulty fuse.
5. Install the replacement fuse into fuse clip F1.
6. Insert the module until it locks securely into place.
7. Install the front cover of the module.
8. Apply power to the PCU containing the ICS module.

SECTION 5 - SUPPORT SERVICES

INTRODUCTION

Bailey Controls is ready to help in the use, application and repair of its products. Contact the nearest sales office to make requests for sales, applications, installation, repair, overhaul and maintenance contract services.

REPLACEMENT PARTS AND ORDERING INFORMATION

When making repairs, order replacement parts from a Bailey sales office. Provide this information:

1. Part description, part number and quantity.
2. Model and serial numbers (if applicable).
3. Bailey instruction manual number, page number and reference figure that identifies the part.

Order parts without commercial descriptions from the nearest Bailey Controls sales office.

Table 5-1. Spare Parts List

Description	Component	Part No.
Fuse 4.0 A/250 V, 0.25 in. x 1.25 in.	F1	194776A14001

TRAINING

Bailey Controls has a modern training facility available for training your personnel. On-site training is also available. Contact a Bailey Controls sales office for specific information and scheduling.

TECHNICAL DOCUMENTATION

Additional copies of this manual, or other Bailey Controls manuals, can be obtained from the nearest Bailey Controls sales office at a reasonable charge.

APPENDIX A - IMCIS02 CONTROL I/O SLAVE MODULE CONFIGURATION

INTRODUCTION

Figure A-1 shows the location of the dipswitches and jumpers used to configure the CIS module. Tables A-1, A-2, A-3, and A-4 give the dipswitch and jumper settings to configure the module. This information is provided as a quick reference guide for personnel installing the NICS01 module. Configuration consists of setting the slave module address (Switch S1), analog output default values (Switch S2), analog output mode (Switch S3), digital input voltage level (Jumpers J1 through J3), and DC voltage response time (Jumpers J4 through J6). Refer to the **Control I/O Slave Module (IMCIS02)** instruction manual for detailed instructions.

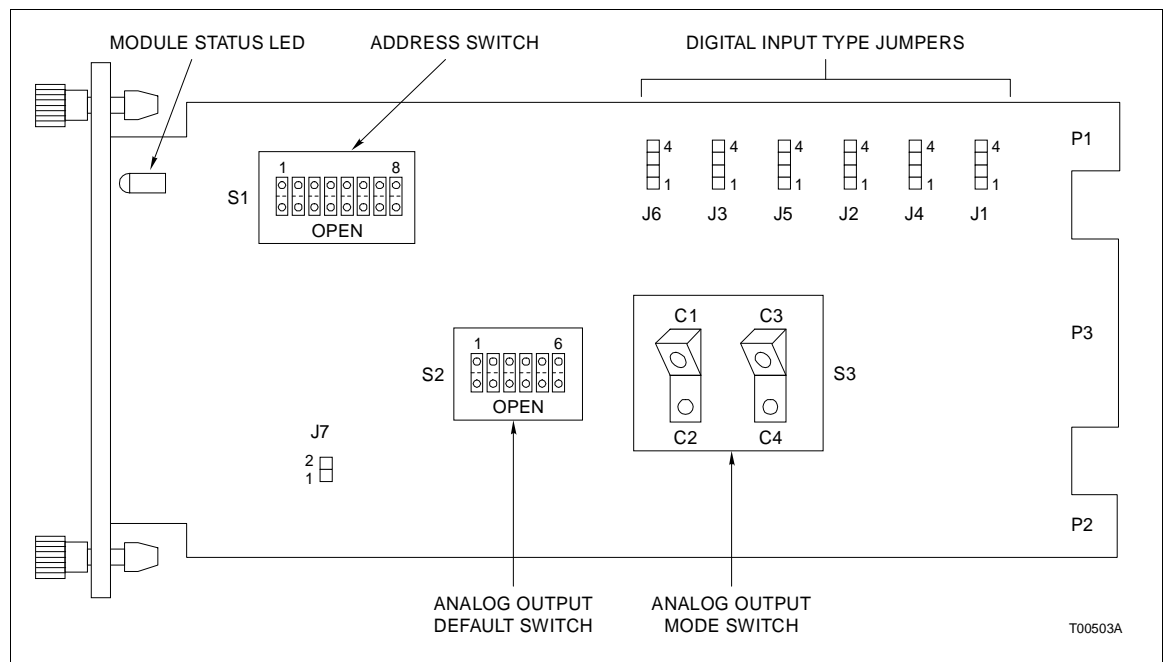

Figure A-1. Control I/O Slave Module

Table A-1. Example Switch S1 Settings

Address	Switch Position	1	2	3	4	5	6	7	8
Example	Binary Value	128	64	32	16	8	4	2	1
0		0	0	0	0	0	0	0	0
16		0	0	0	1	0	0	0	0
32		0	0	1	0	0	0	0	0
48		0	0	1	1	0	0	0	0
63		0	1	1	1	1	1	1	1

NOTE: 0 represents the CLOSED or ON side of the switch. 1 represents the OPEN or OFF side of the switch. Switch positions 1 and 2 must remain closed.

Table A-2. Switch S2 Settings

Analog Output	Time-out Option			Power Up State		
	Switch	Go To Power Up	Hold	Switch	0%	100%
1	2	0	1	3	0	1
2	5	0	1	6	0	1

NOTE: 0 represents the CLOSED or ON side of the switch. 1 represents the OPEN or OFF side of the switch. Switch Positions 1 and 4 are not used and must be set to 0 or CLOSED state.

Table A-3. Switch S3 Settings

Analog Output	Switch Position	
	Current Mode	Voltage Mode
1	C1	C2
2	C3	C4

NOTE: Current Mode = 4 to 20 mA, Voltage Mode = 1 to 5 VDC+

Table A-4. Jumpers J1 through J6 Settings

Digital Input	Jumper	120 VAC	125 VDC Slow	125 VDC Fast	24 VDC Slow	24 VDC Fast
1	1	1-2	2-3	2-3	3-4	3-4
	4	1-2	2-3	3-4	2-3	3-4
2	2	1-2	2-3	2-3	3-4	3-4
	5	1-2	2-3	3-4	2-3	3-4
3	3	1-2	2-3	2-3	3-4	3-4
	6	1-2	2-3	3-4	2-3	3-4

NOTE: Slow = 17 millisecond response time, Fast = 1.5 millisecond response time. **Do not** remove Jumper 7 or the module will operate erratically.

APPENDIX B - IMCOM03 AND IMCOM04 CONTROLLER MODULE CONFIGURATION

INTRODUCTION

Figure B-1 shows the location of the dipswitches and jumpers used to configure the COM module. Tables B-1, B-2, B-3, and B-4 give the dipswitch and jumper settings to configure the module. This information is provided as a quick reference guide for personnel installing the NICS01 module. Configuration consists of setting the analog output types and defaults (Switches S2 and S3), operating mode and module address (Switch S4), and digital input types (Jumpers J1 through J3). Refer to the **Controller Modules (IMCOM03/04)** instruction manual for detailed instructions.

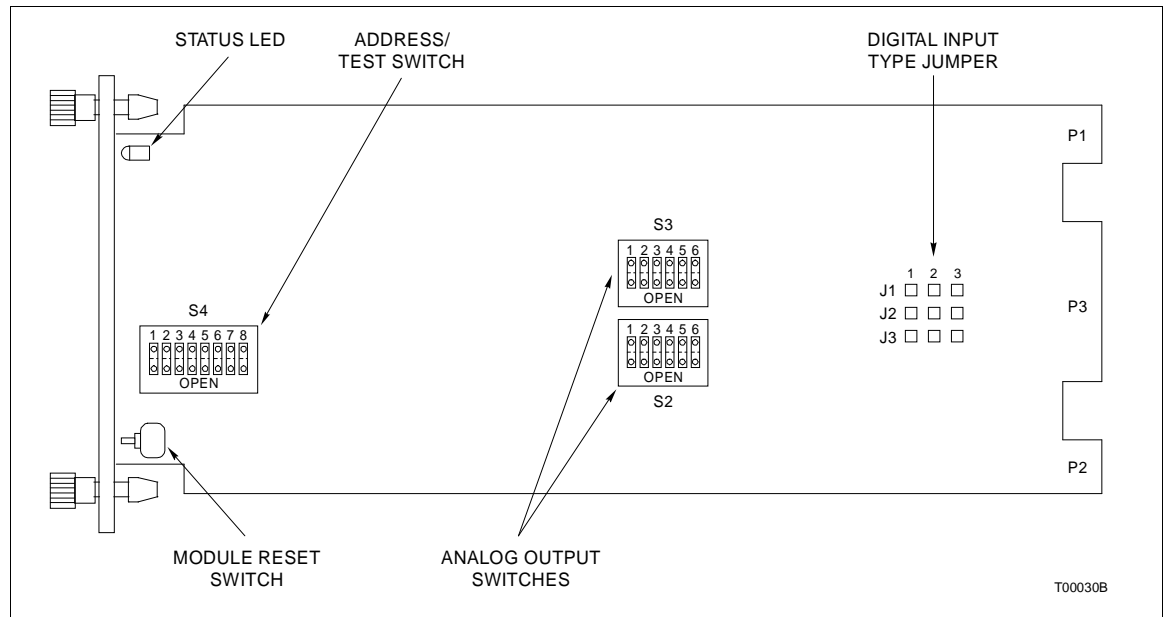

Figure B-1. Controller Module

Table B-1. Switch S2 and S3 Settings

Switch Positions						Function
1	2	3	4	5	6	
1						5.25 VDC analog output during power up.
0						0.75 VDC analog output during power up.
	1	0				Holds last analog output value on time-out. Goes to power up value on time-out.
	0	1				
			0	1	0	Yields voltage output (1 to 5 VDC).
			1	0	1	Yields current output (4 to 20 mADC).

NOTE: 0 represents the CLOSED or ON side of the switch. 1 represents the OPEN or OFF side of the switch.

Table B-2. Switch S4 Settings (Modes)

Function	Switch Position							
	1	2	3	4	5	6	7	8
Normal mode:								
Normal operation	0	0	0	0	0	0	0	0
NVRAM initialization	0	1	0	0	0	0	0	0
Configuration lockout	0	0	1	0	0	0	0	0

NOTE: 0 represents the CLOSED or ON side of the switch. 1 represents the OPEN or OFF side of the switch.

Table B-3. Switch S4 Settings (Module Address)

Address Example	Switch Position	4	5	6	7	8
	Binary Value	16	8	4	2	1
0		0	0	0	0	0
8		0	1	0	0	0
16		1	0	0	0	0
24		1	1	0	0	0
31		1	1	1	1	1

NOTE: 0 represents the CLOSED or ON side of the switch. 1 represents the OPEN or OFF side of the switch.

Table B-4. Jumper J1, J2 and J3 Settings

Jumper Position	Digital Input Type
1-2	24 VDC
2-3	125 VDC

APPENDIX C - IMQRC01 QUICK RESPONSE CONTROLLER MODULE CONFIGURATION

INTRODUCTION

Figure C-1 shows the location of the dipswitches and jumpers used to configure the QRC module. Tables C-1, C-2, C-3, and C-4 give the dipswitch and jumper settings to configure the module. This information is provided as a quick reference guide for personnel installing the NICS01 module. Configuration consists of setting the analog output types and defaults (Switches S2 and S3), operating mode and module address (Switch S4), and digital input types (Jumpers J1 through J3). Refer to the **Quick Response Controller (IMQRC01)** instruction manual for detailed instructions.

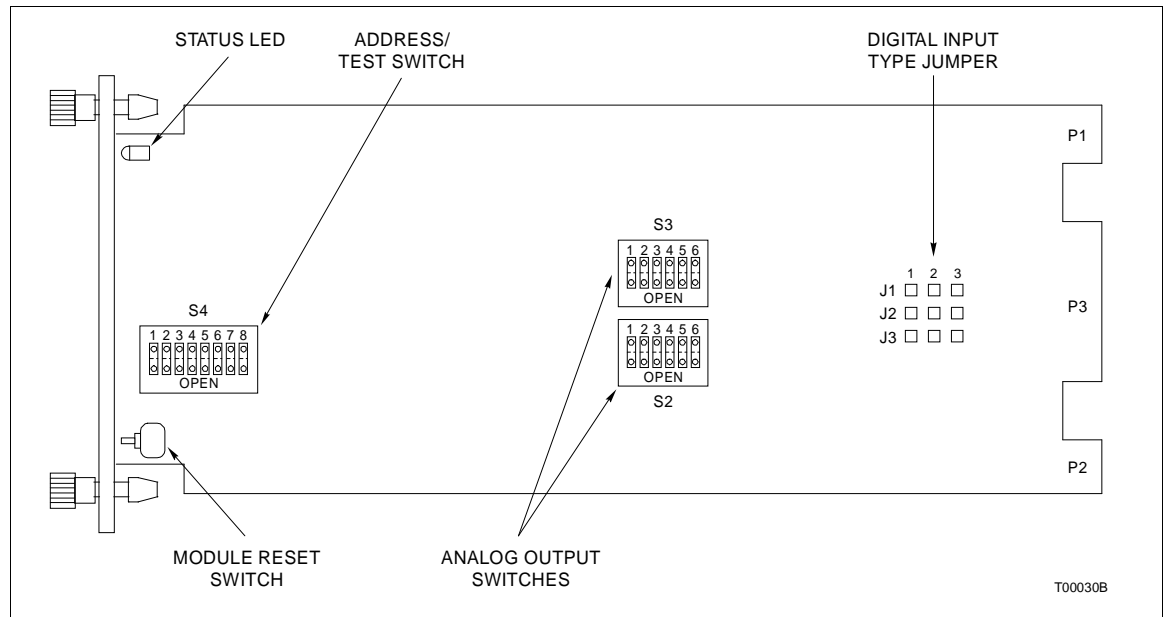

Figure C-1. Quick Response Controller Module

Table C-1. Switch S2 and S3 Settings

Switch Positions						Function
1	2	3	4	5	6	
1						5.25 VDC analog output during power up.
0						0.75 VDC analog output during power up.
	1	0				Holds last analog output value on time-out. Goes to power up value on time-out.
	0	1				
			0	1	0	Yields voltage output (1 to 5 VDC).
			1	0	1	Yields current output (4 to 20 mADC).

NOTE: 0 represents the CLOSED or ON side of the switch. 1 represents the OPEN or OFF side of the switch.

Table C-2. Switch S4 Settings (Modes)

Function	Switch Position							
	1	2	3	4	5	6	7	8
Normal mode:								
Normal operation	0	0	0	0	0	0	0	0
NVRAM initialization	0	1	0	0	0	0	0	0
Configuration lockout	0	0	1	0	0	0	0	0

NOTE: 0 represents the CLOSED or ON side of the switch. 1 represents the OPEN or OFF side of the switch.

Table C-3. Switch S4 Settings (Module Address)

Address Example	Switch Position	4	5	6	7	8
	Binary Value	16	8	4	2	1
0		0	0	0	0	0
8		0	1	0	0	0
16		1	0	0	0	0
24		1	1	0	0	0
31		1	1	1	1	1

NOTE: 0 represents the CLOSED or ON side of the switch. 1 represents the OPEN or OFF side of the switch.

Table C-4. Jumper J1, J2 and J3 Settings

Jumper Position	Digital Input Type
1-2	24 VDC
2-3	125VDC

APPENDIX D - IMQRS02 QUICK RESPONSE SLAVE MODULE CONFIGURATION

INTRODUCTION

Figure D-1 shows the location of the dipswitches and jumpers used to configure the QRS module. Tables D-1, D-2, D-3, and D-4 give the dipswitch and jumper settings to configure the module. This information is provided as a quick reference guide for personnel installing the NICS01 module. Configuration consists of setting the slave module address (Switch S1), analog output default values (Switch S2), analog output mode (Switch S3), digital input voltage level (Jumpers J1 through J3), and DC voltage response time (Jumpers J4 through J6). Refer to the **Quick Response Slave Module (IMQRS02)** instruction manual for detailed instructions.

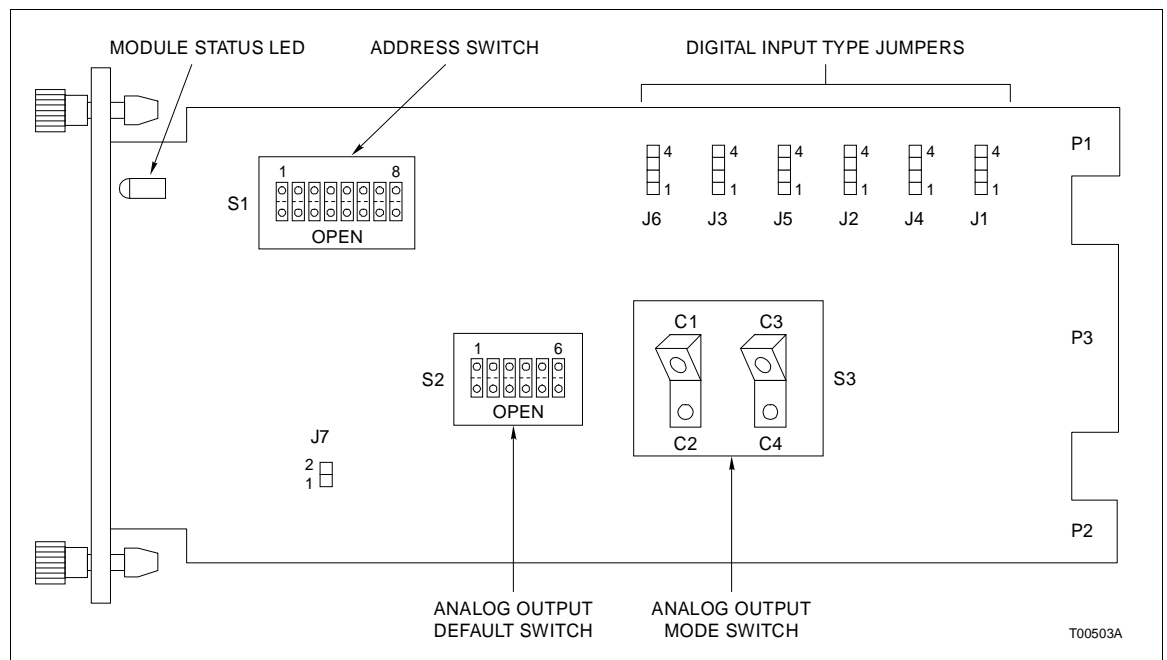

Figure D-1. Quick Response Slave Module

Table D-1. Example Switch S1 Settings

Address	Switch Position	1	2	3	4	5	6	7	8
Example	Binary Value	128	64	32	16	8	4	2	1
0		0	0	0	0	0	0	0	0
16		0	0	0	1	0	0	0	0
32		0	0	1	0	0	0	0	0
48		0	0	1	1	0	0	0	0
63		0	1	1	1	1	1	1	1

NOTE: 0 represents the CLOSED or ON side of the switch. 1 represents the OPEN or OFF side of the switch. Switch positions 1 and 2 must remain closed.

Table D-2. Switch S2 Settings

Analog Output	Time-out Option			Power Up State		
	Switch	Go To Power Up	Hold	Switch	0%	100%
1	2	0	1	3	0	1
2	5	0	1	6	0	1

NOTE: 0 represents the CLOSED or ON side of the switch. 1 represents the OPEN or OFF side of the switch. Switch Positions 1 and 4 are not used and must be set to 0 or CLOSED state.

Table D-3. Switch S3 Settings

Analog Output	Switch Position	
	Current Mode	Voltage Mode
1	C1	C2
2	C3	C4

NOTE: Current Mode = 4 to 20 mA, Voltage Mode = 1 to 5 VDC+

Table D-4. Jumpers J1 through J6 Settings

Digital Input	Jumper	120 VAC	125 VDC Slow	125 VDC Fast	24 VDC Slow	24 VDC Fast
1	1	1-2	2-3	2-3	3-4	3-4
	4	1-2	2-3	3-4	2-3	3-4
2	2	1-2	2-3	2-3	3-4	3-4
	5	1-2	2-3	3-4	2-3	3-4
3	3	1-2	2-3	2-3	3-4	3-4
	6	1-2	2-3	3-4	2-3	3-4

NOTE: Slow = 17 millisecond response time, Fast = 1.5 millisecond response time. **Do not** remove Jumper 7 or the module will operate erratically.

APPENDIX E - IISAC01 ANALOG CONTROL STATION CONFIGURATION

INTRODUCTION

Figure E-1 shows the location of the dipswitches and jumpers used to configure the SAC station. Tables E-1, E-2, E-3, E-4, and E-5 give the dipswitch and jumper settings to configure the station. This information is provided as a quick reference guide for personnel installing the NICS01 module. Configuration consists of setting the operating mode, communications rate and station address (Switch S1). The auto bypass, output and electric drive options (Switch S2) along with the bar graph display option (Switches S3 and S4) must be set. Jumpers J1 through J3 set the manual override, electric drive type and normal operation options. Refer to the **Analog Control Station (IISAC01)** instruction manual for detailed instructions.

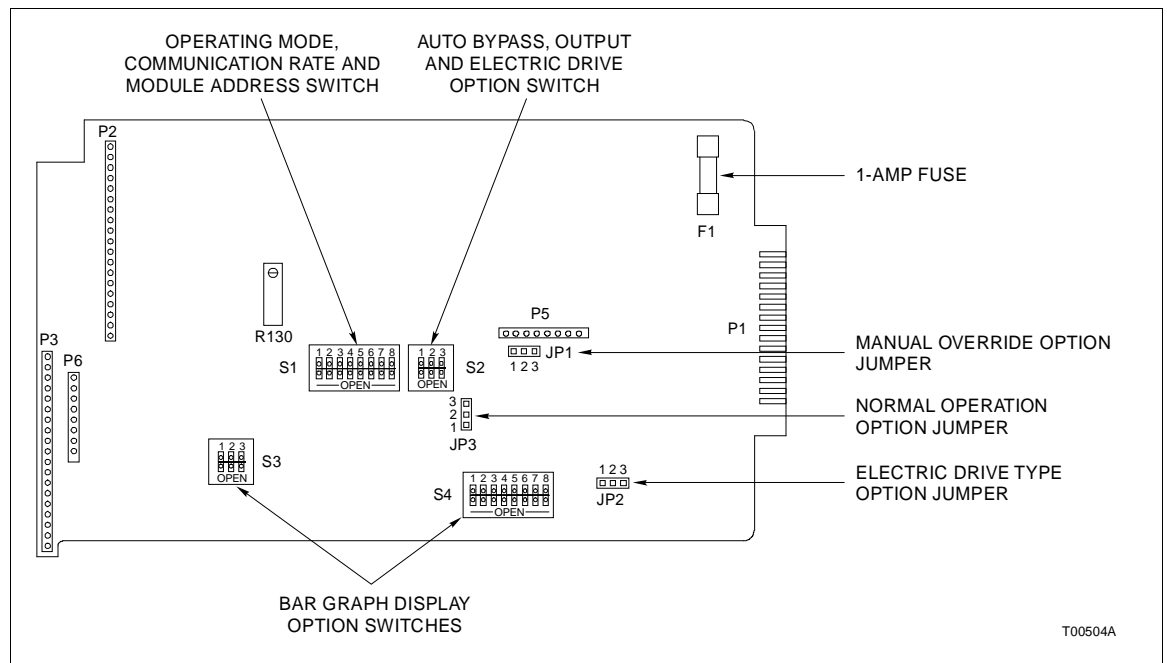

Figure E-1. Analog Control Station

Table E-1. Switch S1 Settings

Switch Positions		Function
1	2	
1		Diagnostics mode.
0		Normal mode.
	1	Enables 40 kbaud communication rate (IMMFP01/02/03).
	0	Enables 5 kbaud communication rate.

Table E-1. Switch S1 Settings (continued)

Address Example	Switch Position						
	3	4	5	6	7	8	
	Binary Value						
	32	16	8	4	2	1	
0	0	0	0	0	0	0	
16	0	1	0	0	0	0	
32	1	0	0	0	0	0	
48	1	1	0	0	0	0	
63	1	1	1	1	1	1	

NOTE: 0 represents the CLOSED or ON side of the switch. 1 represents the OPEN or OFF side of the switch.

Table E-2. Switch S2 Settings

Switch Position			Function
1	2	3	
1			Enables auto bypass.
0			Disables auto bypass.
	1		Reverse demand output.
	0		Normal demand output.
		1	Enables electric drive.
		0	Disables electric drive.

NOTE: 0 represents the CLOSED or ON side of the switch. 1 represents the OPEN or OFF side of the switch.

Table E-3. Switch S3 Settings

Switch Position 123	Bar Graph Display Options			Alphanumeric Display
	VAR	OUT	SET	
000 ¹	Blank	Blank	N/A	DO
001 ¹	Blank	AI1	N/A	DO ³
010	Blank	AI1 and DO ²	N/A	Blank and DO
011	AI1	Blank	N/A	DO
100	Blank	DO	N/A	DO
101	AI1	DO	N/A	DO
110 ¹	AI2	AI1	N/A	DO ³
111 ¹	AI2	DO ³	N/A	DO ³

NOTES: 0 represents the CLOSED or ON side of the switch. 1 represents the OPEN or OFF side of the switch. AI = Analog Input, DO = Demand Output.

1. The only display options available when electric drive option is enabled.
2. VAR switch toggles the display from AI1 to DO.
3. Display is blanked when electric drive is enabled.

Table E-4. Switch S4 Settings

Switch Position	Function
1	Enables square root of AI2.
0	Disables square root of AI2.

Switch Position 2 3 4	Bar Graph Display Options (Normal Mode)			Alphanumeric Display
	VAR	OUT	SET	
0 0 0	PV	CO	SP	PV, CO, SP
0 0 1	PV	AI1	SP	PV, CO, SP
0 1 0	PV	Blank	SP	PV, CO, SP
0 1 1	PV	All On	SP	PV, CO, SP
1 0 0	AI2	CO	SP	PV, CO, SP
1 0 1	AI2	AI1	SP	PV, CO, SP
1 1 0	AI2	Blank	SP	PV, CO, SP
1 1 1	AI2	All On	SP	PV, CO, SP

Switch Position 5678	Bar Graph Display Options (Bypass Mode)			Alphanumeric Display
	VAR	OUT	SET	
0 0 0 0 ¹	Blank	AI1	N/A	DO ²
0 0 0 1	Blank	DO	N/A	DO
0 0 1 0	AI1	DO	N/A	DO
0 0 1 1	DO	DO	N/A	DO
0 1 0 0	DO	AI1	N/A	DO
0 1 0 1 ¹	AI2	AI1	N/A	DO ²
0 1 1 0	AI2	DO	N/A	DO
0 1 1 1	PV(MFP)	AI1	N/A	PV, DO
1 0 0 0	PV(MFP)	DO	N/A	PV, DO
1 0 0 1 ¹	Blank	Blank	N/A	DO ²

NOTES: 0 represents the CLOSED or ON side of the switch. 1 represents the OPEN or OFF side of the switch.

AI = Analog Input, CO = Control Output, DO = Demand Output, PV = Process Variable, SP = Set Point.

1. The only display options available when electric drive is enabled.

2. Alphanumeric display is blanked when electric drive is enabled.

Table E-5. Jumper JP1, JP2, and JP3 Settings

Jumper	Jumper Position	Function
JP1	1-2	Enable manual override switch.
	2-3	Disable manual override switch.
JP2 ¹	1-2	RW type electric drive.
	2-3	Universal type electric drive.
JP3	1-2	Normal operation.
	2-3	Factory setting ² .

NOTES:

1. This jumper is labeled JP4 on stations that are revision 6638095A1.

2. This setting used during factory testing. **Do not** use this setting during normal operation.

Table E-6. Electric Drive Mode Display Options

Standalone Display Mode (Switch S3 Positions) 1 2 3	Bypass Display Mode (Switch S4 Positions) 5 6 7 8	Bar Graph		Action on Control Output
		VAR	OUT	
0 0 1	0 0 0 0	Blank	AI1	AI1 to CO
1 1 0	0 1 0 1	AI2	AI1	AI1 to CO
1 1 1	1 0 0 1	AI2	AI1	AI2 to CO

NOTE: 0 represents the CLOSED or ON side of the switch. 1 represents the OPEN or OFF side of the switch. AI = Analog Input, CO = Control Output.

APPENDIX F - NDCS03 DIGITAL CONTROL STATION CONFIGURATION

INTRODUCTION

Figures F-1 and F-2 show the location of the dipshunts, dipswitches and jumpers used to configure the DCS station. Tables F-1, F-2, F-3, and F-4 give the dipswitch, dipshunt and jumper settings to configure the station. This information is provided as a quick reference guide for personnel installing the NICS01 module. Configuration consists of setting the analog input type (Dipshunt XU16) and control output type (Jumpers J1 and J2) on the bypass board. Setting the station address (Switch S1) and options (Jumpers JP1 through JP5) on the station board is also required. Refer to the **Digital Control Station (NDCS03)** instruction manual for detailed instructions.

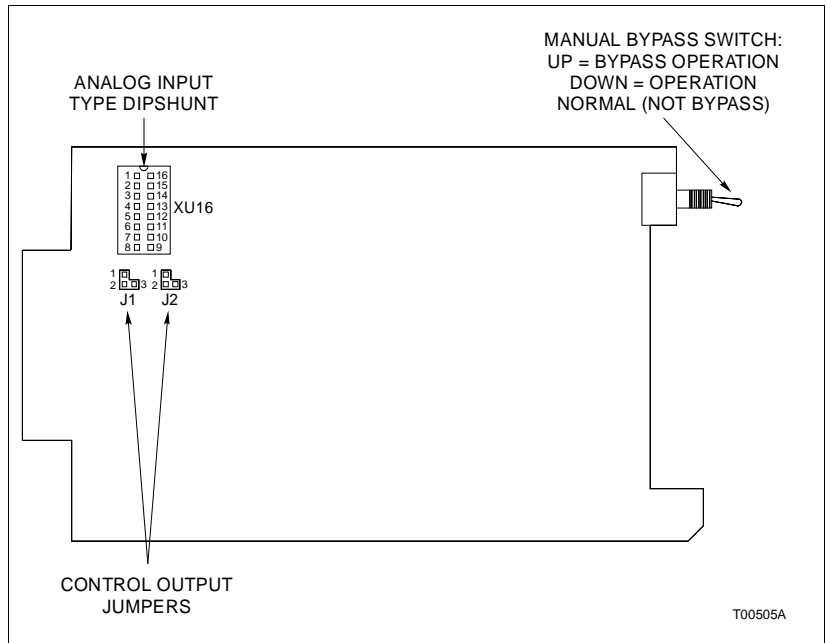

Figure F-1. Bypass Board

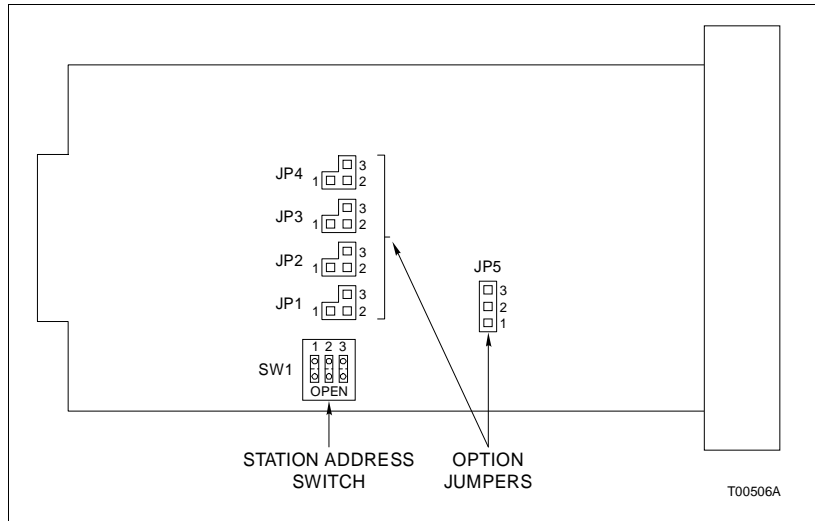

Figure F-2. Digital Control Station Board

Table F-1. Dipshunt XU16 Settings

Strap Numbers								Function
1	2	3	4	5	6	7	8	
0	0	1	1	0	0	1	1	4 to 20 mA analog input ¹ .
1	1	0	0	1	1	0	0	Universal actuator analog input.
0	0	0	0	1	1	0	0	RW electric drive analog input ¹ .
1	1	0	0	0	0	1	1	4 to 20 mA analog input.

NOTES: 0 = Open or cut jumper (cut jumpers at both ends to completely remove), 1 = Intact or shorted jumper.

1. Connected to the 4 to 20 mA output locally.

Table F-2. Jumper J1 and J2 Settings

Jumper	Jumper Position	Function
J1	1-2	RW electric drive operation.
J2	1-2	Universal electric drive operation.
J1	2-3	RW electric drive operation.
J2	2-3	Universal electric drive operation.

NOTE: Jumper settings do not affect 4 to 20 mA outputs.

Table F-3. Switch S1 Settings

Station Address	Switch Position		
	1	2	3
0	0	0	0
1	0	0	1
2	0	1	0
3	0	1	1
4	1	0	0
5	1	0	1
6	1	1	0
7	1	1	1

NOTE: 0 represents the CLOSED or ON side of the switch. 1 represents the OPEN or OFF side of the switch.

Table F-4. Jumpers J1 through J5 Settings

Jumper	Jumper Position	Function
JP1	1-2	Enable auto bypass.
	2-3	Disable auto bypass.
JP2	1-2	Enable reverse acting output when in bypass.
	2-3	Disable reverse acting output when in bypass.
JP3	1-2	No external analog input displayed on OUT bar graph when in normal mode of operation.
	2-3	External analog input displayed on OUT bar graph when in normal mode of operation.
JP4	1-2	External analog input displayed on OUT bar graph when in bypass mode of operation.
	2-3	External analog input displayed on VAR bar graph when in bypass mode of operation.
JP5	1-2	Select bright intensity.
	2-3	Select dim intensity.

APPENDIX G - NDIS01 DIGITAL INDICATOR STATION CONFIGURATION

INTRODUCTION

Figure G-1 shows the location of the dipswitches and jumpers used to configure the DIS station. Tables G-1 and G-2 give the dipswitch and jumper settings to configure the station. This information is provided as a quick reference guide for personnel installing the NICS01 module. Configuration consists of setting the station address (Switch S1) and display brightness (Jumper JP1). Refer to the **Digital Indicator Station (NDIS01)** instruction manual for detailed instructions.

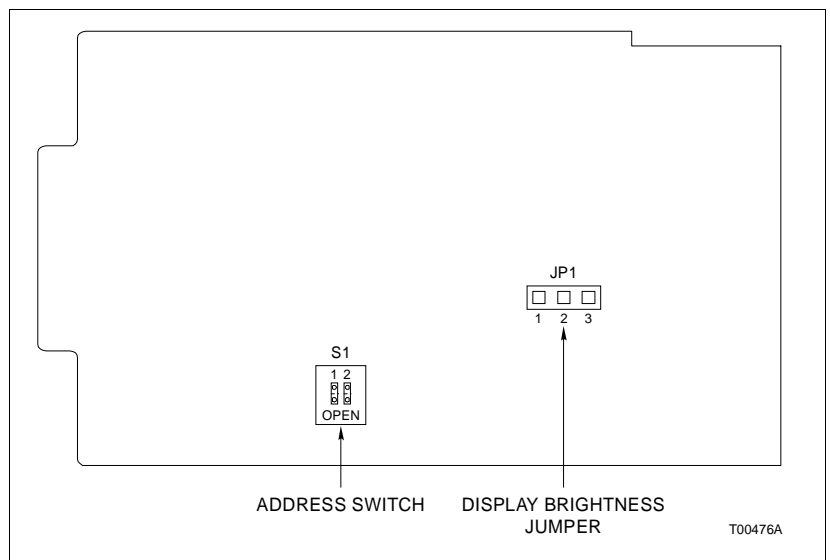

Figure G-1. Digital Indicator Station

Table G-1. Address Switch Settings

Station Address	Switch Position	
	1	2
8	0	0
9	0	1
10	1	0
11	1	1

NOTE: 0 represents the CLOSED or ON side of the switch. 1 represents the OPEN or OFF side of the switch.

Table G-2. Jumper J1 Settings

Jumper	Jumper Position	Function
JP1	1-2	Select bright intensity.
	2-3	Select dim intensity.

Index

C	
Cables	1-4, 2-3
Configuring dipswitches	2-3
F	
Fuse replacement procedures.....	4-2
Fuses.....	2-2
G	
Glossary	1-2
I	
I/O, power, and serial link wiring.....	2-7
IISAC01 configuration	E-1
IMCIS02 configuration	A-1
IMQRC01 configuration.....	C-1
IMQRS02 configuration	D-1
INCOM03/04 configuration	B-1
Installation	2-2
Instruction content	1-2
Intended user	1-2
M	
Maintenance schedule	3-1
Manual usage.....	1-2
Module replacement procedures.....	4-1

N	
NDCS03 configuration	F-1
NDIS01 configuration.....	G-1
O	
Overview	1-1
R	
References.....	1-4
Related equipment.....	1-4
Replacement parts/ordering information.....	5-1
S	
Setup.....	2-2
Spare parts	5-1
Special handling.....	2-1
Specifications	1-3
T	
Technical documentation	5-1
Training.....	5-1
U	
Unpacking and inspection.....	2-2

Visit *Elsag Bailey* on the World Wide Web at <http://www.bailey.com>

Our worldwide staff of professionals is ready to meet *your* needs for process automation.
For the location nearest you, please contact the appropriate regional office.

AMERICAS

29801 Euclid Avenue
Wickliffe, Ohio USA 44092
Telephone 1-216-585-8500
Telefax 1-216-585-8756

ASIA/PACIFIC

152 Beach Road
Gateway East #20-04
Singapore 189721
Telephone 65-391-0800
Telefax 65-292-9011

EUROPE, AFRICA, MIDDLE EAST

Via Puccini 2
16154 Genoa, Italy
Telephone 39-10-6582-943
Telefax 39-10-6582-941

GERMANY

Graefstrasse 97
D-60487 Frankfurt Main
Germany
Telephone 49-69-799-0
Telefax 49-69-799-2406